

Top End Gasket Set



BIG TWIN



OE Brand
ORIGINAL EQUIPMENT

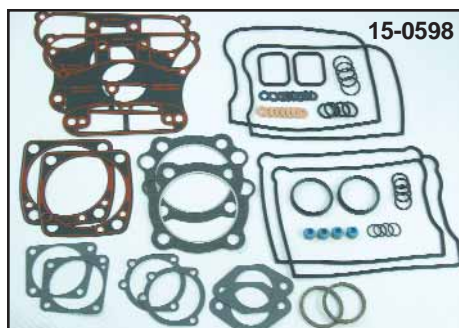
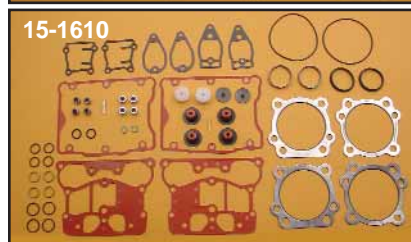
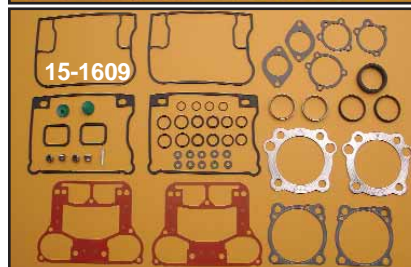
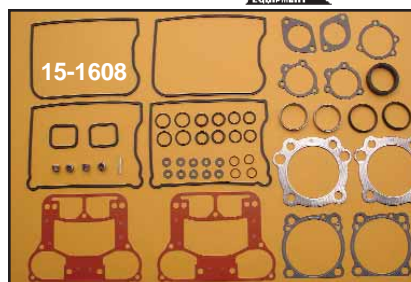
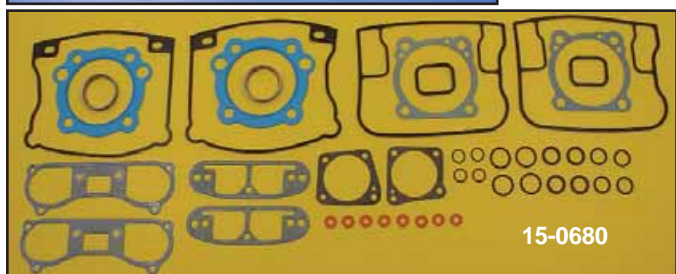

GB Top End Kits include all gaskets and O-rings including pushrod corks from the cylinder base and up. Perfect for Piston and Valve jobs.

VT No.	OEM	Years	Fits
15-0598	17033-83	1984-91	V2 Evo
15-0680	17040-92A	1992-99	V2 Evo
15-0377	17052-99	1999-up	TC-88

Top End Kits for Big Twin models

15-1608	17033-83A	1984-91 FXST, 1984-91 FXR, 1984-91 FLT
15-1609	17040-92A	1992-98 FLT, 1992-94 FXR, 1992-99 FXST, 1992-98 FXD
15-1610	17052-99	1999-up FLT, 1999-up FXD, 2000-up FXST

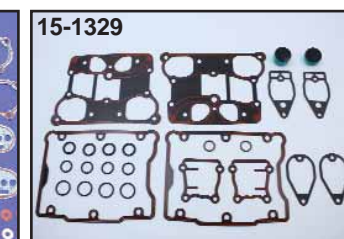
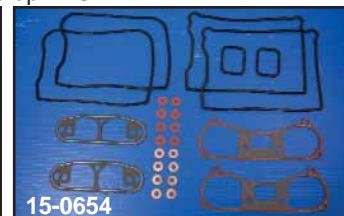
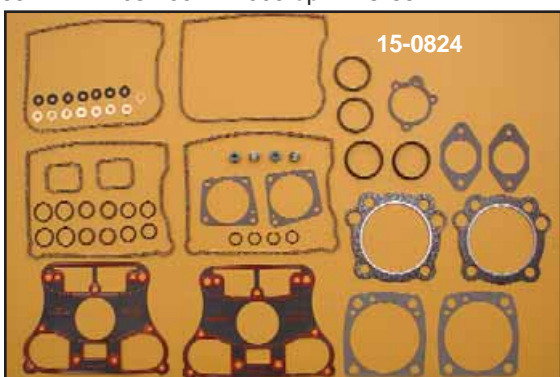

James Top End Sets

VT No.	OEM	Years	Models
15-0824	17033-83	1984-91	Evo
15-0859	17033-83A	1984-91	Evo
15-1191	—	1984-91	Evo 3 3/8" Big Bore
15-0825	17040-92A	1992-99	Evo
15-1192	—	1992-99	Evo 3 3/8" Big Bore
15-1209	17052-99	1999-up	TC-88

Rocker Box Gasket Kits for Evo include upper and lower gaskets in Cork or Molded O-Ring type with bolt seals and washers for both heads.

James	GB	OEM	Type	Fits
15-0845	15-0315	17033-83R	Cork	84-91 1340 BT
15-0847	15-0654	17038-90	O-Ring	84-91 1340 BT
15-0848	14-0932	17042-92	O-Ring	92-99 1340 BT
15-1210	15-1329	—	O-Ring	99-up TC-88
15-1221	—	—	O-Ring	S&S Two Piece Rocker Covers